

## Sliding table saw minimax sc 2c



With swiveling saw blade and high quality sliding carriage made of anodized aluminum

### Article number ▾

5504215

### Brand ▾

Holzkraft

### Availability ▾

No stock available

Information:

Next availability

Expected on calendar week 19/2024



### Catalog directory ▾

Woodworking machinery » Circular saw / Sliding table saws » Sliding table saws » minimax sc 2c

### Purchase ▾

Minimum 1 pc(s).

### Shipping informations ▾

Packaging Metrics		Weights		Delivery		Other	
Length	850 mm	Gross	320 kg	Delivery	Carrier	DualUse	✘
Width	1,680 mm	Net	315 kg	Content	1 pc(s).	SCIP	n/a
Height	1,180 mm					SVHC	No

### Root data ▾

Country of origin	EAN	Custom number	Quantity unit
 Italy	4036351042020	84659120	pc(s).

### Video ▾

[www.youtube.com/watch?v=mJ8PXwXENIk](https://www.youtube.com/watch?v=mJ8PXwXENIk)



MADE IN ITALY

### Description ▾

- Cutting plane directly on the saw blade
- Large-sized grey cast iron saw unit double-attached to the casting table – warranty for stability, precision, smooth running and long service life
- Precision-guided aluminium format slide, anodized as standard
- 10-year HOLZKRAFT warranty on wear of the guideways of the sliding slide
- Parallel stop as standard with round rod guide and fine adjustment
- Large work table made of milled grey cast iron
- Quiet running and precise cuts
- Standard table widening and table extension allow easy work with larger workpieces
- Extendable aluminium telescopic stop with angle adjustment and two professional folding stops
- Made in Italy

## Significant Features ▼



## Media informations ▼



**Rip fence**

- With round bar guide and fine adjustment

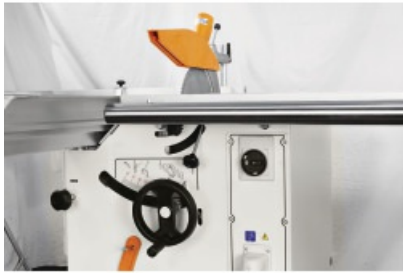

**Saw unit made of gray cast iron**

- Attached directly to the cast table in two places
- Can be swiveled precisely using the handwheel and scale for exact miter cuts



**Aluminium sliding table**

- Equipped with a proven ball contact system  
Permanently smooth-running
- Guides made of hardened and ground steel, 15% harder than conventional steel
- Guides Pressed in and not glued
- Smooth-running, low-noise and reliable
- 10-year wood power guarantee for wear on the guideways

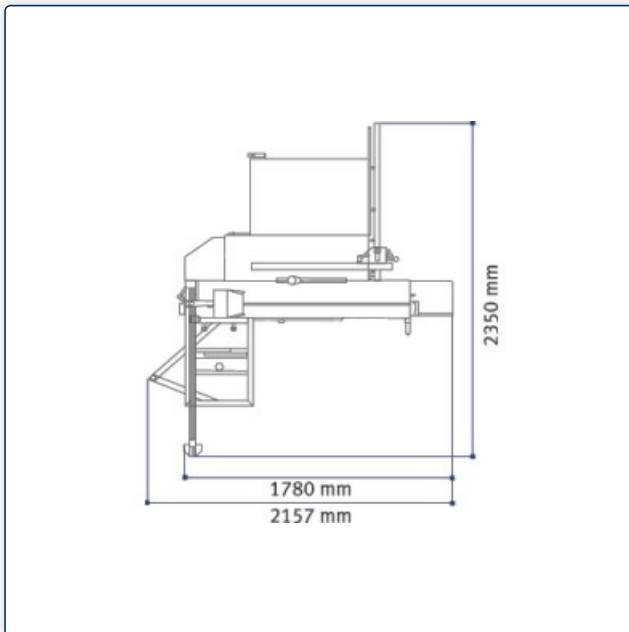

**Technical data** ▾

Dimensions and weights			
Net weight approx.	295 kg		
Extraction port			
Extraction port diameter bottom	120 mm	Saw blade protection extraction port diameter	60 mm
Footprint			
Transport width	700 mm	Length	802 mm

Width/depth	615 mm	Space requirement length	3860 mm
Space requiremen width/depth	2750 mm	Explanation about space requirement The dimensions take into account maximum travel distances or usable lengths	
Work area length	1000 mm	Work area width/depth	2000 mm
Explanation about work area	Please add the given dimensions with the required space to obtain the free space recommended for the machine.		
<b>Electrical Data</b>			
Supply voltage	400 V	Mains frequency	50 Hz
Drive motor output	4,0 kW	Duty type drive motor	S6
Duty cycle drive motor	40 %		
<b>Sliding carriage and table</b>			
Sliding carriage length	1600 mm	Sliding carriage width	270 mm
Sliding carriage height	124 mm	Table length	1020 mm
Table width	325 mm	Work height	860 mm
<b>Circular saw unit</b>			
Max. cutting width with rip fence	900 mm	Max. cross cut width left from saw blade	1660 mm
Trimming length	1600 mm	Saw blade angle	90 – 45 °
Max. cutting height 90°	100 mm	Max. cutting height 45°	79 mm
(Main) saw blade diameter	315 mm	(Main) saw blade speed	3500 min <sup>-1</sup>

## Equipment ▼

Anodised aluminium sliding sizing carriage	✓	Handle for sliding carriage	✓
Claming frame	✓	Saw rip fence	with round rod guide
Stops	Two professional folding stops	Clamp sleigh	✓
Eccentric clamp	✓	Table broadening	✓
Table lengthening	✓	Saw blade cover	✓

## Accessories ▼



**Scoring saw blade**  
VSB 80/12

**Article number** ▼ 5514001

**Availability** ▼ In stock  
Immediate delivery

**Purchase** ▼ Minimum 1 pc(s).

**Price informations** ▼



---



**Push handle**  
AIGNER Quickly

**Article number** ▼ 5850205

**Availability** ▼ In stock  
Immediate delivery

**Purchase** ▼ Minimum 1 pc(s).

**Price informations** ▼





### Extraction system connection set 120/58 mm



**Article number** ▼  
5146060

**Availability** ▼  
In stock  
Immediate delivery

**Purchase** ▼  
Minimum 1 pc(s).

**Price informations** ▼



### Edging and production cut circular saw blade KSB-BF 315/48



Highest quality level especially for industrial applications on stationary machines

**Article number** ▼  
5263148

**Availability** ▼  
In stock  
Immediate delivery

**Purchase** ▼  
Minimum 1 pc(s).

**Price informations** ▼



### Cut-to-size alternating teeth circular saw blade KSB-WZ 315/28



**Article number** ▼  
5263128

**Availability** ▼  
In stock  
Immediate delivery

**Purchase** ▼  
Minimum 1 pc(s).

**Price informations** ▼



### Circular saw blade set 315 mm



HOLZKRAFT sizing saw blades comply with the highest quality level especially for industrial applications on stationary machines

**Article number** ▼  
5260315

**Availability** ▼  
In stock  
Immediate delivery

**Purchase** ▼  
Minimum 1 pc(s).

**Price informations** ▼



### Special format and edging circular saw blade KSB-SFB 300/96



Highest quality level especially for industrial applications on stationary machines

**Article number** ▼  
5263097

**Availability** ▼  
In stock  
Immediate delivery

**Purchase** ▼  
Minimum 1 pc(s).

**Price informations** ▼



### Cutting flat tooth circular saw blade KSB-ZF 300/14



Highest quality level especially for industrial applications on stationary machines

**Article number** ▼  
5263014

**Availability** ▼  
In stock  
Immediate delivery

**Purchase** ▼  
Minimum 1 pc(s).

**Price informations** ▼



## Universal swing hood PSH-U



**Article number** ▼  
5510500

**Availability** ▼  
In stock  
Immediate delivery

**Purchase** ▼  
Minimum 1 pc(s).

**Price informations** ▼



## Blade guard PSH



**Article number** ▼  
5510404

**Availability** ▼  
No stock available  
Information:  
Next availability  
Expected on  
calendar week  
19/2024

**Purchase** ▼  
Minimum 1 pc(s).

**Price informations** ▼



## Edging and production cut circular saw blade KSB-BF 315/60



Highest quality level especially for industrial applications on stationary machines

**Article number** ▼  
5263160

**Availability** ▼  
In stock  
Immediate delivery

**Purchase** ▼  
Minimum 1 pc(s).

**Price informations** ▼



## Additional work table on the sledge



**Article number** ▼  
5510409

**Availability** ▼  
No stock available  
Information:  
Next availability  
Expected on  
calendar week  
13/2024

**Purchase** ▼  
Minimum 1 pc(s).

**Price informations** ▼



## Mitre fence 1060 mm, with telescopic guide



**Article number** ▼  
5514315

**Availability** ▼  
No stock available  
Information:  
Next availability  
Unknown

**Purchase** ▼  
Minimum 1 pc(s).

**Price informations** ▼



## Splitting wedge positively guided for saw blade for saw blade Ø 250 - 350 mm / 2.8 mm riving knife thickness



**Article number** ▼  
5515001

**Availability** ▼  
In stock  
Immediate delivery

**Purchase** ▼  
Minimum 1 pc(s).

**Price informations** ▼



### Push stick AIGNER



**Article number** ▼  
5850136

**Availability** ▼  
In stock  
Immediate delivery

**Purchase** ▼  
Minimum 1 pc(s).

**Price informations** ▼



### Deflector AIGNER



**Article number** ▼  
5850157

**Availability** ▼  
In stock  
Immediate delivery

**Purchase** ▼  
Minimum 1 pc(s).

**Price informations** ▼

Prices on this data sheet are recommended retail prices, subject to change, in €, plus VAT at the statutory rate, plus packaging, shipping, transport, unloading, assembly and, if applicable, instruction costs. Sales prices of the dealers can deviate. No liability is accepted for printing errors, mistakes or incorrect presentation. Technical and optical changes are reserved. Illustration partly with optional accessories.