

Sandblasters

SSK 2.5

For clean blasting without pollution of the working environment



Article number ▼

6204003

Brand ▼

Unicraft

Availability ▼

No stock available

Information:

Incoming stocks

Expected on calendar week 41/2023

Catalog directory ▼

Workshop and lifting technology »

Bodywork and workshop equipment » Sand

blaster

Purchase ▼

Minimum 3 pc(s).



Delivery content ▼

- High quality blasting gun with ceramic nozzle
- 4 ceramic nozzles (4/5/6/7 mm)
- 5 replacement foils for viewing windows

Shipping informations ▼

Packaging Metrics		Weights		Delivery		Other	
Length	1,310 mm	Gross	105 kg	Delivery	Carrier	DualUse	✘
Width	1,020 mm	Net	90 kg	Content	3 pc(s).	SCIP	n/a
Height	760 mm					SVHC	No

Root data ▼

Country of origin	EAN	Custom number	Quantity unit
China	4036351222521	84243010	pc(s).

Description ▼

- Suitable for various blasting materials, eg quartz, glass ball, plastic ball, etc.
- Ideal for cleaning, rust removal or paint removal of metal parts of all kinds, eg engine parts, fittings, signs, housings, rims, hinges
- High-quality work gloves made of latex are firmly attached to the housing
- Optimum vision and work safety during workpiece machining due to the lens with glued-on protective foil
- Dust-free work due to circumferential seals on cover and door frame
- Stable storage grid allows laying of workpieces in the cabin interior
- With drain opening for changing the blasting material
- Suction pipe for the blasting material attached to the bottom of the collecting container
- With compressed air connection on the outside
- Glass bead blasting, corundum blasting, silicon carbide, plastic blasting, etc. can be used

Room amenities:

- Two large side doors for loading and unloading on both sides, even for longer workpieces
- Integrated extraction system with replaceable air filter
- Airflow control via foot pedal
- 2 blasting guns: One fixed and one free moving blasting gun
- Three separate switches for on / off, exhaust and cabin lighting
- Two fluorescent tubes (230 volts), in separate housing with protective screen and interchangeable protective foil, including five replacement foils
- Regulation of working pressure via pressure regulator with manometer

Media informations



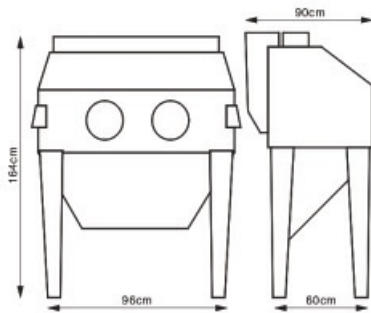

Technical data ▼

General features			
Air requirement average, approx.	200 – 350 l/min	Working pressure	4.1 – 8.0 bar
Abrasive grain size recommended	0.2 – 0.3 mm	Max. abrasive grain size	0.125 – 0.45 mm
Max. load of grid	120 kg	Max. weight of blast media	50 kg
Extraction performance	2.5 m³/h	Extraction unit negative pressure	8.5 kPa
Extraction unit volume flow	156 m³/h		
Dimensions and weights			
Length (product) approx.	960 mm	Width/depth (product) approx.	900 mm
Height (product) approx.	1640 mm	Net weight approx.	90 kg
Cabin volume	310 l	Cabin interior length	945 mm
Cabin interior width	605 mm	Cabin interior height	605 mm
Diameter of hand hole	195 mm		
Electrical Data			
Extraction absorbed power	1200 W		

Side door (see drawing)



Side door A	541 mm	Side door B	575 mm
Side door C	316 mm	Side door D	265 mm

Accessories 



Sandblasting nozzle set
Ceramic 4/5/6/7 mm



Article number  **Availability** 

6204130

Purchase 

In stock
Immediate delivery



Minimum 1 PU

Price informations 



Sandblasting nozzle
6 mm



Article number  **Availability** 

6204132

Purchase 

In stock
Immediate delivery



Minimum 1 pc(s).

Price informations 



Air filter
F-SSK3



Article number  **Availability** 

6204123

Purchase 

In stock
Immediate delivery



Minimum 1 pc(s).

Price informations 



Viewing window
SS-SSK2.5 / 3 / 3.1



Article number  **Availability** 

6204122

Purchase 

In stock
Immediate delivery



Minimum 1 pc(s).

Price informations 



Sandblasting gun
SSP SSK1 / 2 / 2.5



Article number  **Availability** 

6204101

Purchase 

In stock
Immediate delivery



Minimum 1 pc(s).

Price informations 



Protective film lighting
SFB SSK3 / 3.1



Article number  **Availability** 

6204126

Purchase 

In stock
Immediate delivery

Minimum 1 PU

Price informations 



Protective screen lighting SSB SSK3



Article number ▼
6204125

Availability ▼
In stock
Immediate delivery

Purchase ▼
Minimum 1 pc(s).

Price informations ▼



Fluorescent tube LSR SSK3



Article number ▼
6204127

Availability ▼
In stock
Immediate delivery

Purchase ▼
Minimum 1 pc(s).

Price informations ▼



Gloves HS SSK2.5 / 3/4



Article number ▼
6204120

Availability ▼
In stock
Immediate delivery

Purchase ▼
Minimum 1 pair

Price informations ▼



Sandblasting gun SSP-SSK2.5



Article number ▼
6204105

Availability ▼
In stock
Immediate delivery

Purchase ▼
Minimum 1 pc(s).

Price informations ▼



Protective film SF-SSK2 / 2.5 / 3



Article number ▼
6204111

Availability ▼
In stock
Immediate delivery

Purchase ▼
Minimum 1 PU

Price informations ▼



LED light tube for SSK 2.5 / SSK 3 / SSK 3.1



Article number ▼
6204128

Availability ▼
In stock
Immediate delivery

Purchase ▼
Minimum 1 pc(s).

Price informations ▼

Prices on this data sheet are recommended retail prices, subject to change, in €, plus VAT at the statutory rate, plus packaging, shipping, transport, unloading, assembly and, if applicable, instruction costs. Sales prices of the dealers can deviate. No liability is accepted for printing errors, mistakes or incorrect presentation. Technical and optical changes are reserved. Illustration partly with optional accessories.

