

## Combined tube, profile and belt sander KRBS 101



### Article number ▼

3921001

### Brand ▼

Metalkraft

### Availability ▼

Small stock amount  
Article available

### Catalog directory ▼

Metalworking machines » Grinding and polishing machines for metal » Belt grinding machines » Tube and profile end grinding machines

### Purchase ▼

Minimum 1 pc(s).



### Delivery content ▼

- 1x standard sanding belt grain K 40 for stainless steel & grey cast iron sanding
- 2 x chip collecting tanks
- 1 x wrench
- 1 x sanding roller 42 mm

### Shipping informations ▼

Packaging Metrics		Weights		Delivery		Other	
Length	1,330 mm	Gross	173 kg	Delivery	Carrier	DualUse	✘
Width	730 mm	Net	147 kg	Content	1 pc(s).	SCIP	n/a
Height	650 mm					SVHC	No

### Root data ▼

Country of origin	EAN	Custom number	Quantity unit
 China	4036351054757	84602990	pc(s).

### Video ▼

[www.youtube.com/watch?v=pIPRajv2hso](https://www.youtube.com/watch?v=pIPRajv2hso)

### Description ▼

- For deburring with practical workpiece support and chip collecting container
- Convenient operation thanks to easily adjustable clamping device
- The rotating clamping jaws of the clamping device enable secure clamping of square tubes, round tubes and flat steel
- Adjustable grinding angles of 30 - 90 ° and 0 ° - 60 °
- Thanks to the optimized quick-change holder, the tensioner can be changed easily and quickly without tools
- Particularly durable due to larger and improved roller bearings
- Practical grinding wheel holders integrated in the base
- Extensive range of grinding wheels for different pipe diameters available as accessories
- Fast change between pipe grinding and belt grinding possible
- Powerful engine
- Almost all settings can be carried out without tools (operating tool included)
- Large, hinged protective glass with optimum field of vision
- Optimal adaptation to the respective material due to 2 belt speeds (15 m / s ideal for stainless steel and aluminum, 30 m / s perfect for steel)
- With two easily removable chip collecting containers
- Extraction nozzle (Ø 70 mm) for extraction systems available

## Media informations



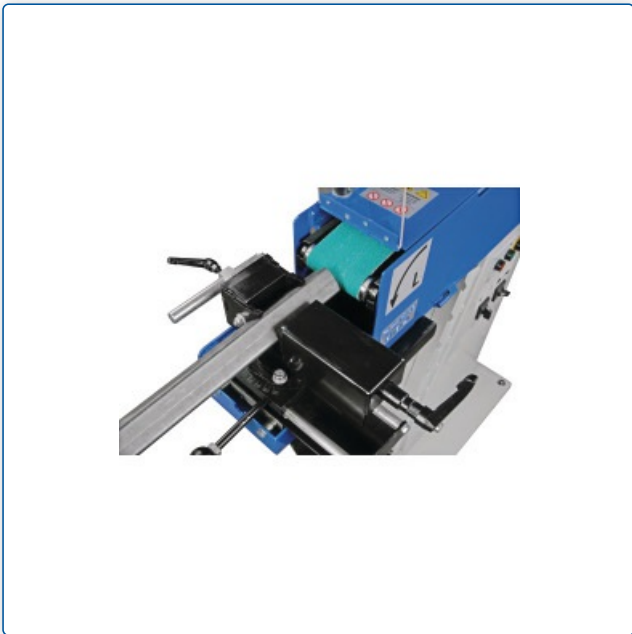
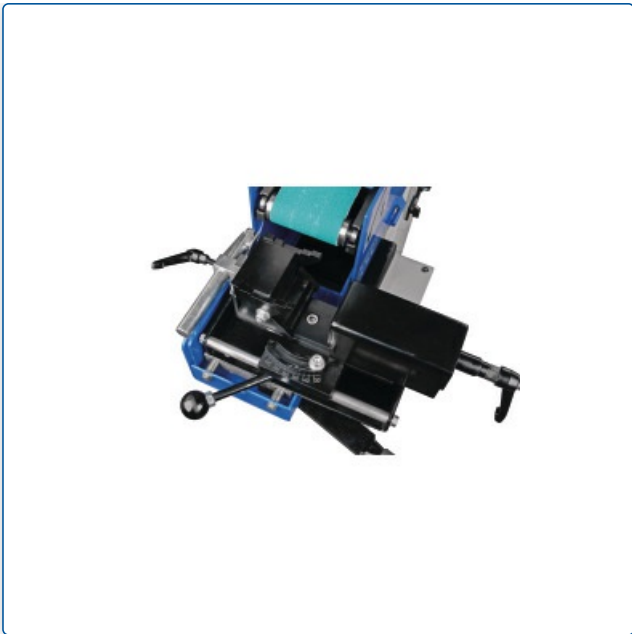

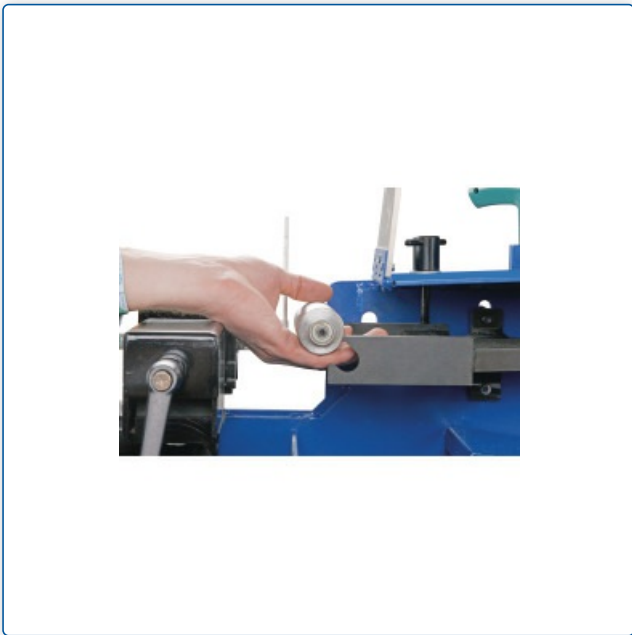
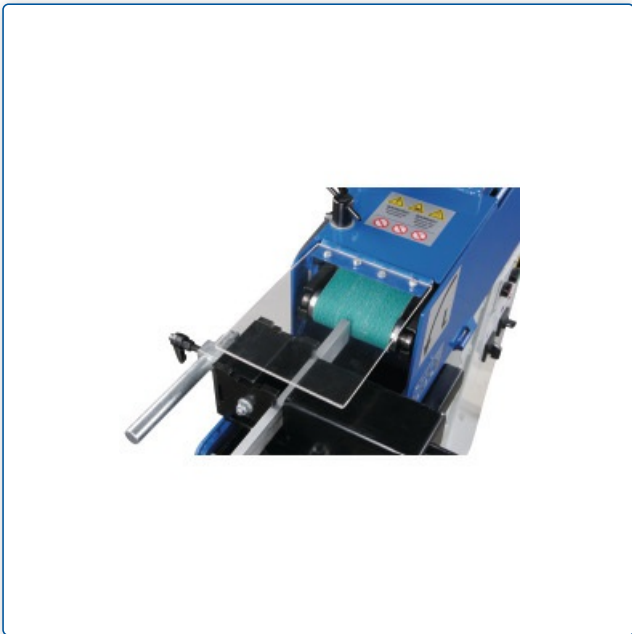
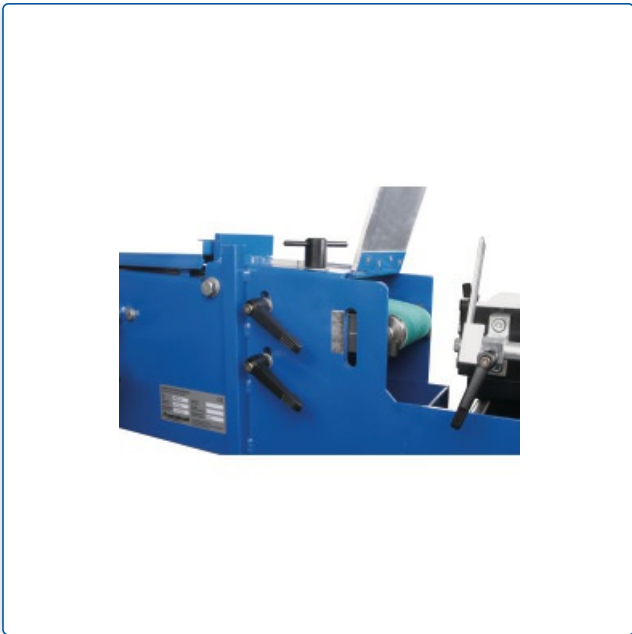







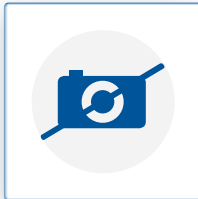

## Technical data ▼

Dimensions and weights			
Length (product) approx.	1250 mm	Width/depth (product) approx.	750 mm
Height (product) approx.	1140 mm	Net weight approx.	159 kg
Electrical Data			
Drive motor output	2.5 / 3.3 kW	Supply voltage	400 V
Mains frequency	50 Hz	Motor speed(s)	1400 / 2800 min <sup>-1</sup>
Sanding machine			
Sanding belt length	2000 mm	Sanding belt width	100 mm
Circumferential belt speed(s)	15/30 m/s	Adjustable grinding angle	30 – 90 (0 – 60) °
Workpiece			
Min. pipe diameter	20 mm	Max. pipe diameter	78 mm
Extraction			
Extraction duct nominal width outside	2 x 74 mm	Extraction duct nominal width inside	2 x 70 mm

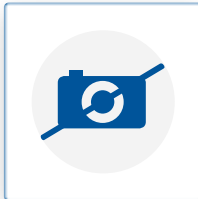
## Accessories ▼

	<b>Roller</b> for 3/8" pipe (17.2 mm)	
<b>Article number</b> <span>▼</span>	<b>Availability</b> <span>▼</span>	<b>Purchase</b> <span>▼</span>
3723050	In stock Immediate delivery	Minimum 1 pc(s).
		<b>Price information</b> <span>▼</span>
	<b>Roller</b> for 1 1/2" pipe (48.3 mm)	
<b>Article number</b> <span>▼</span>	<b>Availability</b> <span>▼</span>	<b>Purchase</b> <span>▼</span>
3723059	In stock Immediate delivery	Minimum 1 pc(s).
		<b>Price information</b> <span>▼</span>
	<b>Roller</b> for 50 mm pipe	
<b>Article number</b> <span>▼</span>	<b>Availability</b> <span>▼</span>	<b>Purchase</b> <span>▼</span>
3723060	In stock Immediate delivery	Minimum 1 pc(s).
		<b>Price information</b> <span>▼</span>
	<b>Roller</b> for 2" pipe (60.3 mm)	
<b>Article number</b> <span>▼</span>	<b>Availability</b> <span>▼</span>	<b>Purchase</b> <span>▼</span>
3723061	In stock Immediate delivery	Minimum 1 pc(s).
		<b>Price information</b> <span>▼</span>

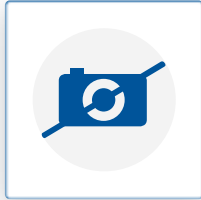

### Roller für 62 mm pipe

Article number ▼  
3723062

Availability ▼  
In stock  
Immediate delivery

Purchase ▼  
Minimum 1 pc(s).

Price informations ▼



### Roller for 2 1/2" pipe (76.1 mm)

Article number ▼  
3723063

Availability ▼  
In stock  
Immediate delivery

Purchase ▼  
Minimum 1 pc(s).

Price informations ▼



### Roller for 78 mm pipe

Article number ▼  
3723064

Availability ▼  
In stock  
Immediate delivery

Purchase ▼  
Minimum 1 pc(s).

Price informations ▼



### Fabric grinding belt for non-ferrous metals, stainless steel, mild steel 2000 x 100 mm K100

Article number ▼  
3724710

Availability ▼  
In stock  
Immediate delivery

Purchase ▼  
Minimum 1 PU (10  
pc(s).)

Price informations ▼



### Fabric grinding belt for non-ferrous metals, stainless steel, mild steel 2000 x 100 mm K120

Article number ▼  
3724712

Availability ▼  
In stock  
Immediate delivery

Purchase ▼  
Minimum 1 PU (10  
pc(s).)

Price informations ▼



### Fabric grinding belt for non-ferrous metals, stainless steel, mild steel 2000 x 100 mm K40

Article number ▼  
3724740

Availability ▼  
In stock  
Immediate delivery

Purchase ▼  
Minimum 1 PU (10  
pc(s).)

Price informations ▼





**Fabric grinding belt for non-ferrous metals,  
stainless steel, mild steel**  
2000 x 100 mm K60



**Article number** ▼  
3724760

**Availability** ▼  
In stock  
Immediate delivery

**Purchase** ▼  
Minimum 1 PU (10  
pc(s).)

**Price informations** ▼

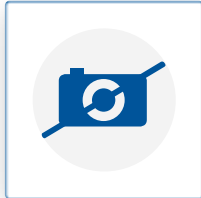

**Roller**  
for 1/2" pipe (21.3 mm)



**Article number** ▼  
3723051

**Availability** ▼  
In stock  
Immediate delivery

**Purchase** ▼  
Minimum 1 pc(s).

**Price informations** ▼



**Fabric grinding belt for stainless steel**  
2000 x 100 mm K100



**Article number** ▼  
3724810

**Availability** ▼  
In stock  
Immediate delivery

**Purchase** ▼  
Minimum 1 PU (10  
pc(s).)

**Price informations** ▼



**Fabric grinding belt for stainless steel**  
2000 x 100 mm K120



**Article number** ▼  
3724812

**Availability** ▼  
In stock  
Immediate delivery

**Purchase** ▼  
Minimum 1 PU (10  
pc(s).)

**Price informations** ▼



**Fabric grinding belt for stainless steel**  
2000 x 100 mm K40



**Article number** ▼  
3724840

**Availability** ▼  
In stock  
Immediate delivery

**Purchase** ▼  
Minimum 1 PU (10  
pc(s).)

**Price informations** ▼

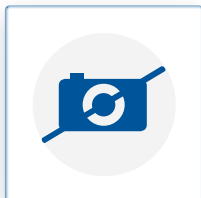

**Roller**  
for 22 mm pipe



**Article number** ▼  
3723052

**Availability** ▼  
In stock  
Immediate delivery

**Purchase** ▼  
Minimum 1 pc(s).

**Price informations** ▼

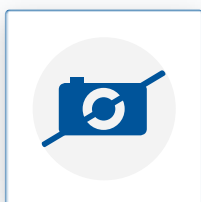

**Roller**  
for 3/4" pipe (26.9 mm)



**Article number** ▼  
3723053

**Availability** ▼  
In stock  
Immediate delivery

**Purchase** ▼  
Minimum 1 pc(s).

**Price informations** ▼



### Roller for 28 mm pipe

Article number ▼  
3723054

Availability ▼  
In stock  
Immediate delivery

Purchase ▼  
Minimum 1 pc(s).

Price informations ▼



### Roller for 1" pipe (33.7 mm)

Article number ▼  
3723055

Availability ▼  
In stock  
Immediate delivery

Purchase ▼  
Minimum 1 pc(s).

Price informations ▼

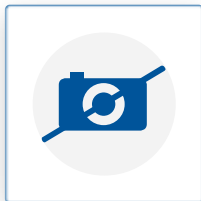

### Roller for 34 mm pipe

Article number ▼  
3723056

Availability ▼  
In stock  
Immediate delivery

Purchase ▼  
Minimum 1 pc(s).

Price informations ▼

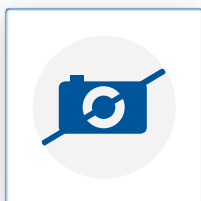

### Roller for 1 1/4" pipe (42.4 mm)

Article number ▼  
3723057

Availability ▼  
In stock  
Immediate delivery

Purchase ▼  
Minimum 1 pc(s).

Price informations ▼

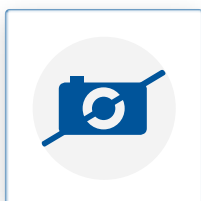

### Roller for 44 mm pipe

Article number ▼  
3723058

Availability ▼  
In stock  
Immediate delivery

Purchase ▼  
Minimum 1 pc(s).

Price informations ▼



### Fabric grinding belt for stainless steel 2000 x 100 mm K60

Article number ▼  
3724860

Availability ▼  
In stock  
Immediate delivery

Purchase ▼  
Minimum 1 PU (10  
pc(s).)

Price informations ▼

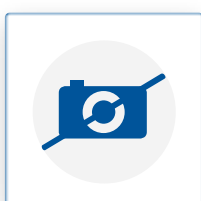

### Roller 42 mm for KRBS 100/101

Article number ▼  
3723065

Availability ▼  
In stock  
Immediate delivery

Purchase ▼  
Minimum 1 pc(s).

Price informations ▼





---

Prices on this data sheet are recommended retail prices, subject to change, in €, plus VAT at the statutory rate, plus packaging, shipping, transport, unloading, assembly and, if applicable, instruction costs. Sales prices of the dealers can deviate. No liability is accepted for printing errors, mistakes or incorrect presentation. Technical and optical changes are reserved. Illustration partly with optional accessories.